



Installation Instructions for the Rinnai Direct Vent Water Heater Vent/Air Intake System

When installing the Rinnai direct vent water heaters, use Rinnai vent/air intake system kits and components only. Installation and service must be performed by a qualified installer, service agency or the gas supplier. Installation must meet all state and local codes regarding installation and location of vent systems for direct vent appliances. The maximum vent length, as stated in the Rinnai Water Heater Owner's Manual and these instructions, should never be exceeded. Follow the instructions below and all instructions located in the Rinnai Water Heater Owner's Manual when installing a vent pipe system. Improper installation of vent piping, or failure to follow all installation instructions completely, can result in property damage, and/or death.

Components needed for direct vent applications:

Refer to the following drawings, of Rinnai vent system components and installations, to determine the parts required for your particular vent system application:

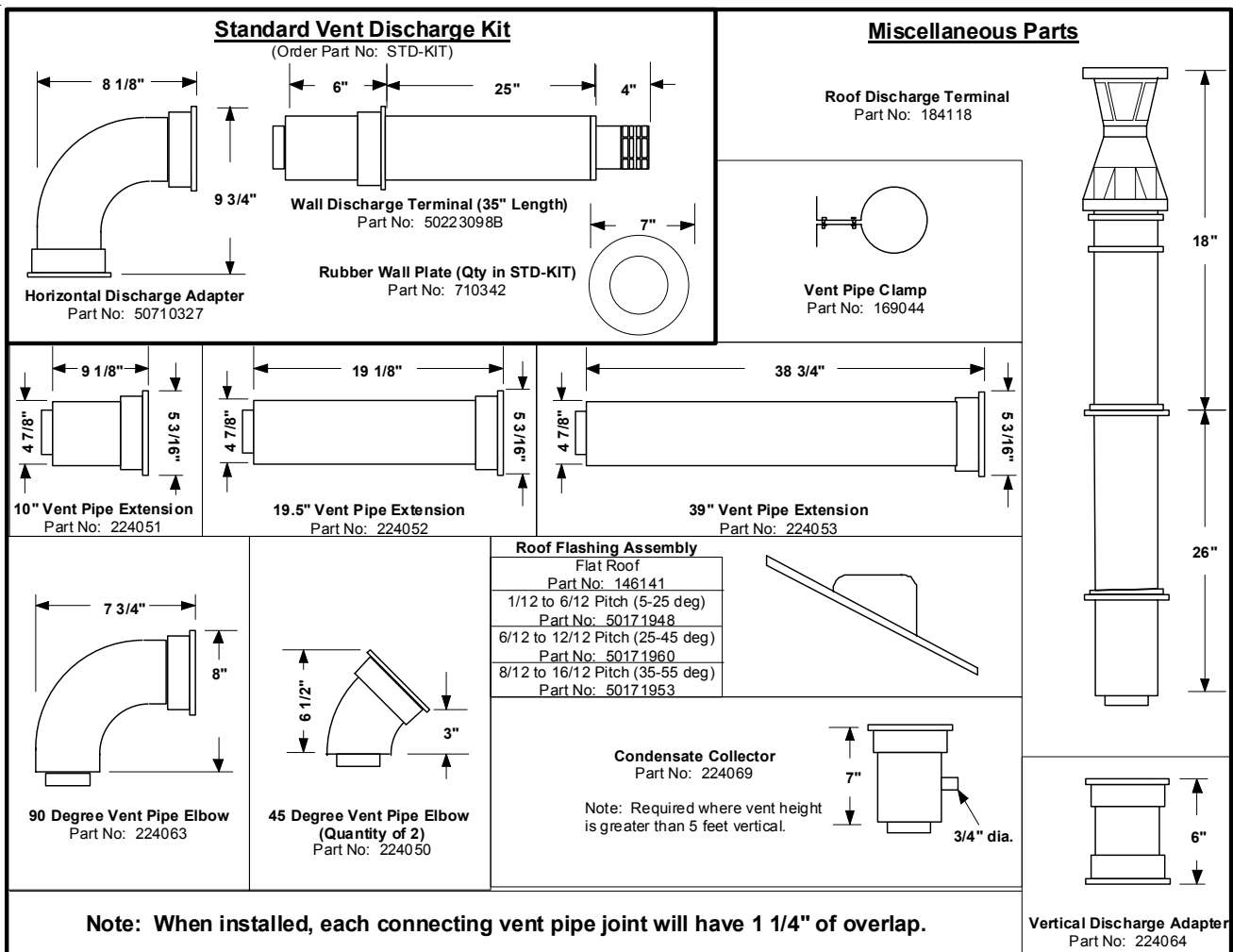

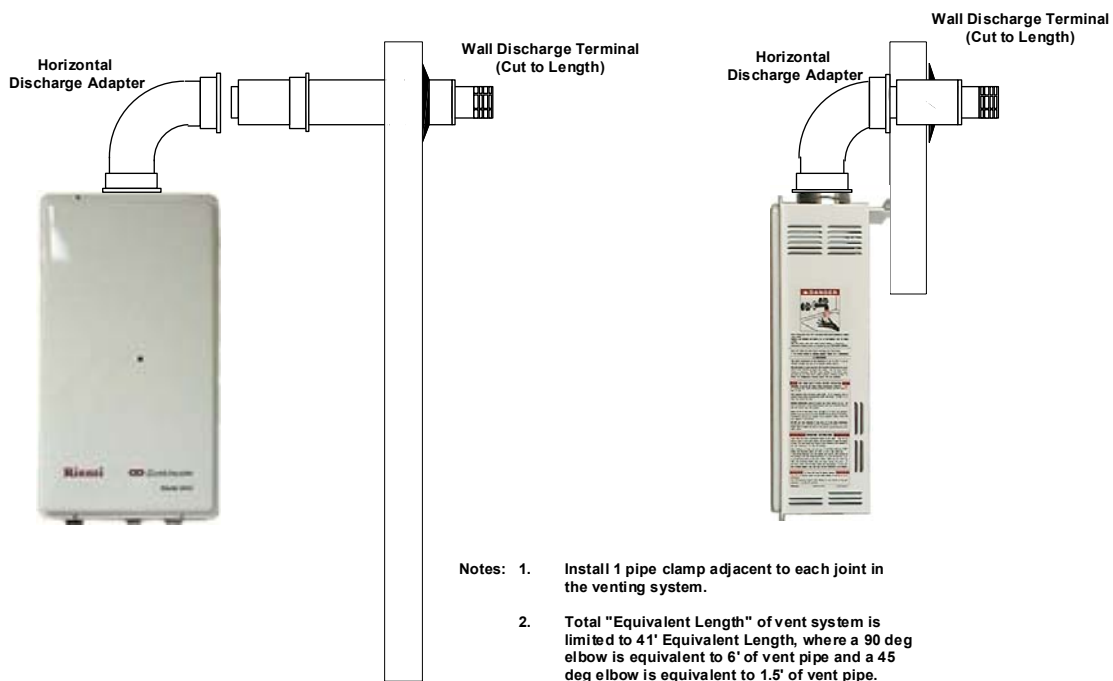

- Notes:
1. Install 1 pipe clamp adjacent to each joint in the venting system.
 2. Total "Equivalent Length" of vent system is limited to 41' Equivalent Length, where a 90 deg elbow is equivalent to 6' of vent pipe and a 45 deg elbow is equivalent to 1.5' of vent pipe.
 3. Regardless of the calculated "Equivalent Length" of vent system, the Maximum Height from the top of the water heater to the top of the highest point in the vent system is limited to 21 feet.

Horizontal Venting with Standard Vent Discharge Kit

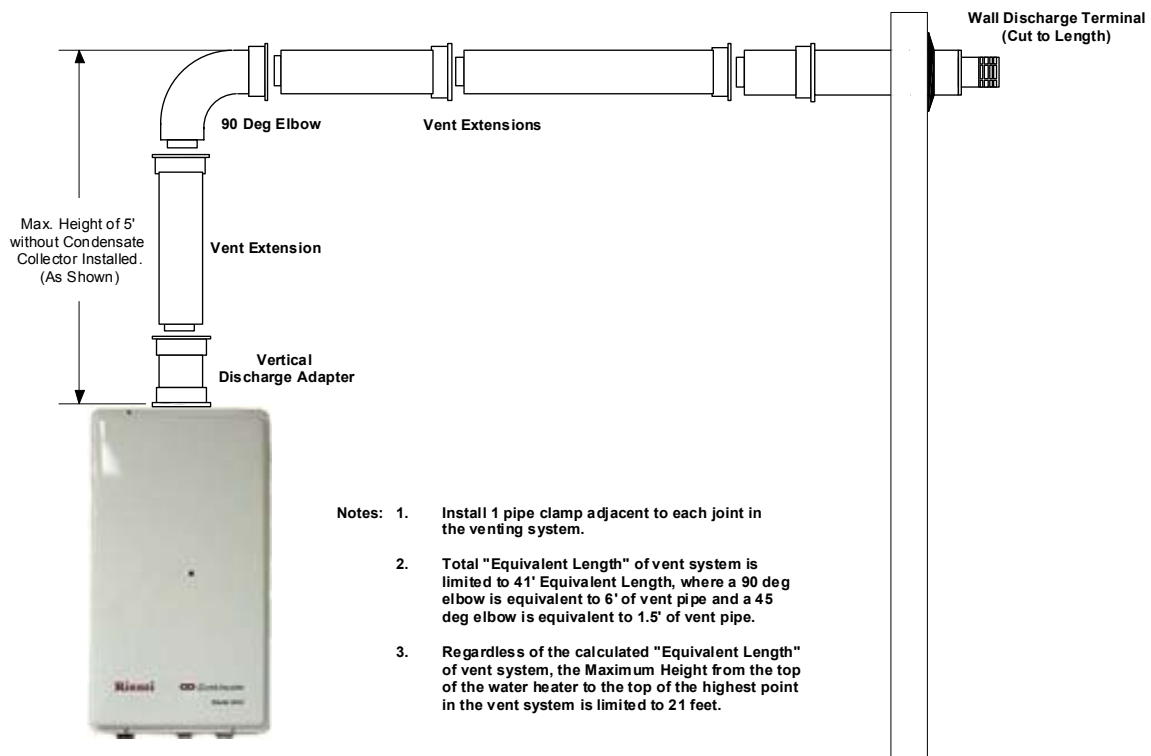

- Notes:
1. Install 1 pipe clamp adjacent to each joint in the venting system.
 2. Total "Equivalent Length" of vent system is limited to 41' Equivalent Length, where a 90 deg elbow is equivalent to 6' of vent pipe and a 45 deg elbow is equivalent to 1.5' of vent pipe.
 3. Regardless of the calculated "Equivalent Length" of vent system, the Maximum Height from the top of the water heater to the top of the highest point in the vent system is limited to 21 feet.

Horizontal Venting - Vent System Heights under 5 feet

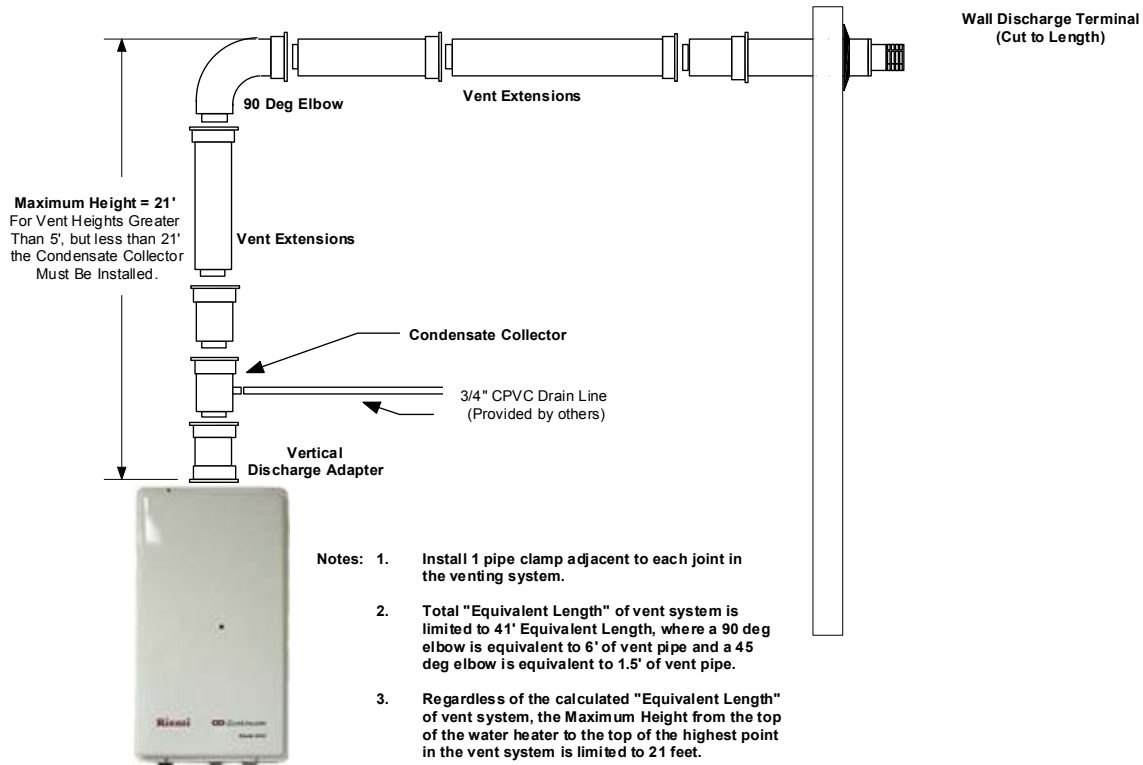

Horizontal Venting - Vent System Heights 5 feet to 21 feet

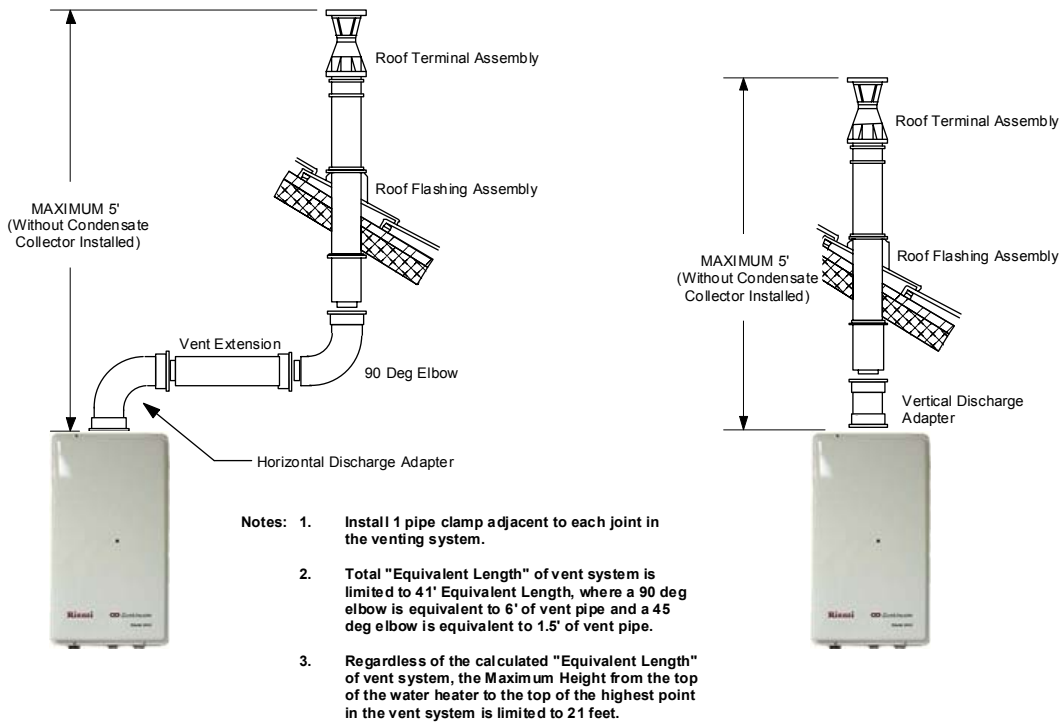

Vertical Venting - Vent System Heights under 5 feet

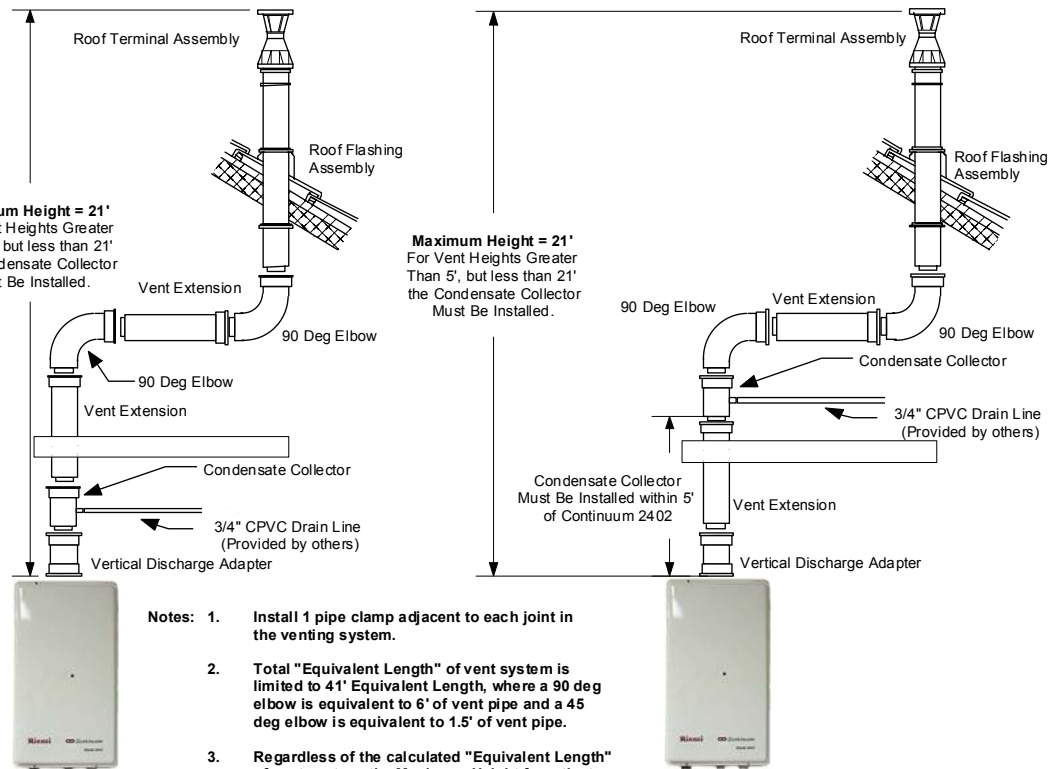

- Notes:**
1. Install 1 pipe clamp adjacent to each joint in the venting system.
 2. Total "Equivalent Length" of vent system is limited to 41' Equivalent Length, where a 90 deg elbow is equivalent to 6' of vent pipe and a 45 deg elbow is equivalent to 1.5' of vent pipe.
 3. Regardless of the calculated "Equivalent Length" of vent system, the Maximum Height from the top of the water heater to the top of the highest point in the vent system is limited to 21 feet.

Vertical Venting - Vent System Heights 5 feet to 21 feet

Refer to the Rinnai Water Heater Owner's Manual for details concerning vent system termination positions/clearances, allowable vent pipe lengths, and proper dip switch selection for your particular vent pipe system. If you do not understand how to configure your vent pipe system and/or how to set dip switches, please contact your Rinnai Products Dealer for assistance.

Prior to the Installation of Rinnai direct vent systems:

- 1) Your Rinnai water heater has two adjustable wall mounting support brackets fitted on the top and bottom of the appliance. When installing a "Standard Vent Discharge Kit" to vent directly out the wall to the back of the water heater, these brackets should be adjusted so that the water heater is spaced its maximum distance of 2" away from the wall. Before cutting the vent terminal to the appropriate length, ensure you have taken into account just how far the heater has been spaced away from the wall.

Installation of Rinnai “Standard Vent Discharge Kit”:

Standard Vent Discharge Kit Installation Type A:

Standard Vent Discharge Kit installation when mounting to and venting directly out an exterior wall:

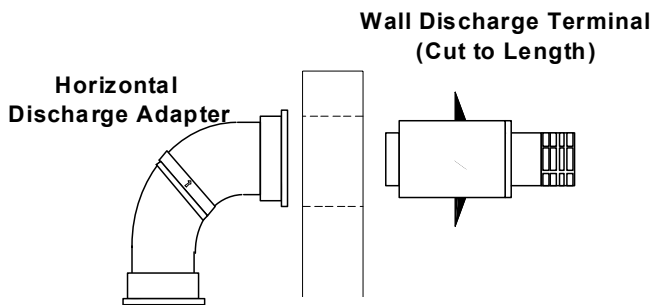

- 1) Locate the direction arrow on the side of the Horizontal Discharge Adapter (see Figure 1). Connect the Horizontal Discharge Adapter to the water heater vent outlet with the direction arrow pointing away from the water heater. Make sure that the rubber seals are seated properly and that the fitting is fully engaged on the water heater.

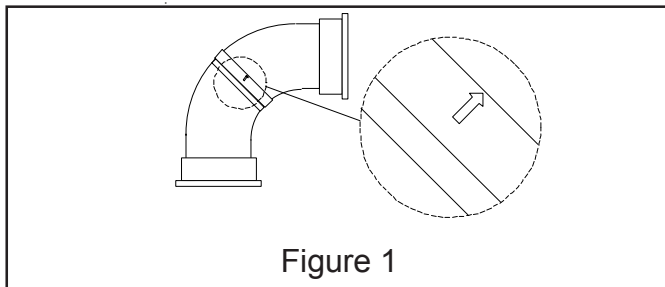

- 2) Turn the Horizontal Discharge Adapter toward the rear of the water heater to the location the vent will penetrate the wall. Place the Wall Discharge Terminal Template (attached at the end of these instructions), between the Horizontal Discharge Adapter and the wall so that the discharge adapter flange is aligned with the “FLANGE” line on the template. Tape the template in place temporarily.

- 3) Remove the Horizontal Discharge Adapter from the water heater, leaving the template taped to the wall.
- 4) Using a pencil, or a sharp scoring tool, mark the “PILOT HOLE” location by pressing hard enough to penetrate the template leaving a mark on the wall. Remove the template from the wall.
- 5) Remove the water heater from the wall, or completely cover it, using plastic and tape, so that no dust or debris will fall into the vent opening or any of the ventilation slots when cutting the opening through the wall.
- 6) Using a 1/4” or smaller drill bit (long enough to drill completely through wall), drill a pilot hole from the inside wall surface completely through the outside wall surface.
IMPORTANT: Be certain the drill bit is kept level and straight during the drilling operation.
- 7) Using scissors, carefully cut the Wall Discharge Terminal Template along the outside edge of the dashed circle labeled “CUT LINE” leaving the hatched “Cut Line Template”.
- 8) Align the “PILOT HOLE” on the “Cut Line Template” with the pilot hole drilled in the wall and using a pencil, carefully trace a cut line on the inside wall surface, along the edge of the “Cut Line Template”. The cut line circle should be 5-1/4” in diameter.
- 9) Repeat Step 8 to trace a cut line on the exterior surface of the wall.
- 10) Using a cutting tool suitable for the wall construction (i.e. drill, skill saw, hole saw, etc.), drill or cut the vent termination hole through the wall along the cut lines drawn in Steps 8 and 9.

- 11) Remove the collar from the Wall Discharge Terminal and discard (see Figure 2).

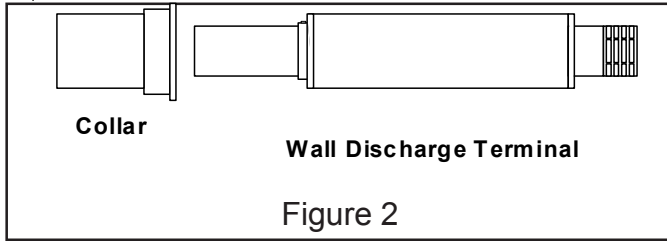

- 12) Loosen the screw on the metal Retaining Ring. Remove the Retaining Ring and the black plastic Alignment Spacer (see Figure 3). Discard the Retaining Ring and the Alignment Spacer.

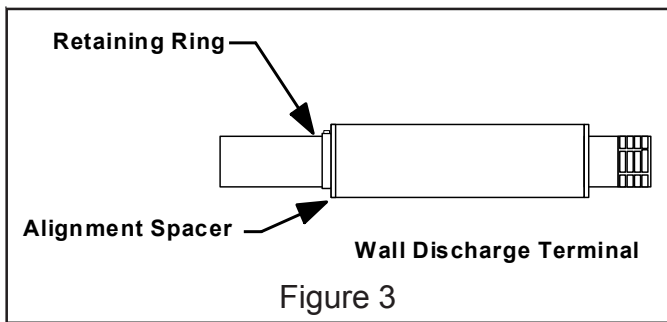

- 13) Disassemble the Wall Discharge Terminal. Remove the metal Exhaust Pipe, black plastic End Cap, and plastic Intake Pipe (see Figure 4).

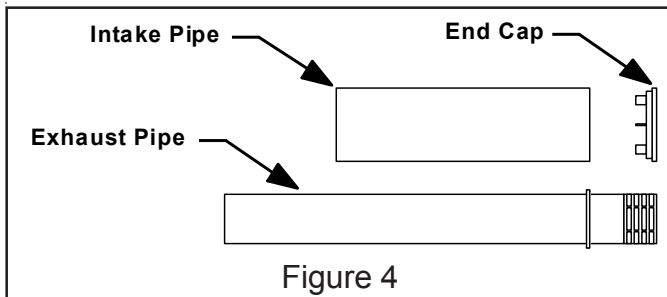

- 14) Measure the total wall thickness through the vent termination hole cut in Step 10. (Measure from the inside surface all the way through to the exterior surface of the wall.)

IMPORTANT: Measure wall thickness twice to be sure you have the correct measurement.

- 15) Add 4" to the wall thickness measured in Step 14 giving you the required length of the plastic Intake Pipe.

- 16) Measure and mark the length calculated in Step 15 onto the plastic Intake pipe. Measure from either end and mark cut line all the way around the Intake Pipe (see Figure 5).

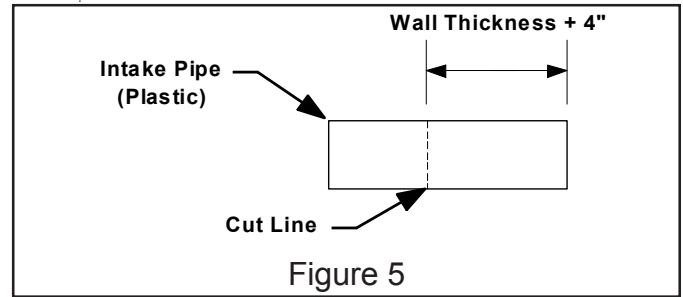

- 17) Use a hack saw and miter box to cut the Intake Pipe along the cut line marked in Step 16.

IMPORTANT: Make sure to cut the pipe squarely. Remove burrs from the pipe using a suitable de-burring tool or coarse sandpaper.

- 18) Add 4 3/4" to the wall thickness measured in Step 14 giving you the required length of the metal Exhaust Pipe.

- 19) Measure and mark the length calculated in Step 18 onto the metal exhaust pipe. Measure from the outside edge of the raised flange and mark a cut line all the way around the Exhaust Pipe (see Figure 6).

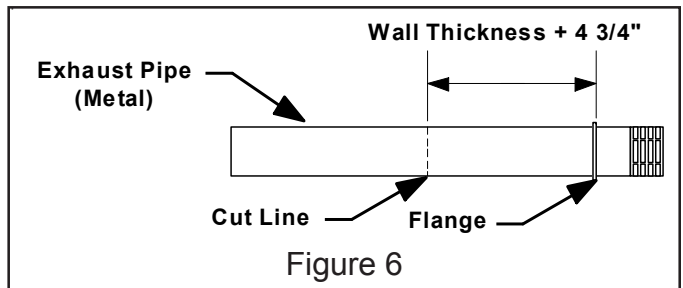

- 20) Use a hack saw and miter box to cut the Exhaust Pipe along the cut line marked in Step 19.

IMPORTANT: Make sure to cut the pipe squarely. Remove burrs from the pipe using a suitable de-burring tool or coarse sandpaper.

- 21) Mount the water heater securely on the wall and install the Horizontal Discharge Adapter, aligning the outlet opening with the vent termination hole.
- 22) From outside the building, slide the plastic Intake Pipe through the vent termination hole into the Horizontal Discharge Adapter, making sure the pipe is pressed all the way into the intake pipe socket of the Horizontal Discharge Adapter.
- 23) Insert the End Cap into the open end of the plastic Intake Pipe.
- 24) Slide the metal Exhaust Pipe through the End Cap opening and through the Intake Pipe into the Horizontal Discharge Adapter, making sure the pipe is pressed all the way into the exhaust pipe socket of the Horizontal Discharge Adapter.
- 25) Seal between the plastic Intake Pipe and the cut openings of the interior and exterior surfaces of the wall, using silicon sealant.
- 26) The decorative wall plate may be installed on the exterior of the building to dress up the installation. Slide the wall plate over the vent pipe assembly and seal and secure using silicon sealant.

Standard Vent Discharge Kit Installation Type B:

Standard Vent Discharge Kit installation when mounting to interior wall and venting directly out an exterior wall to the left or right of the water heater:

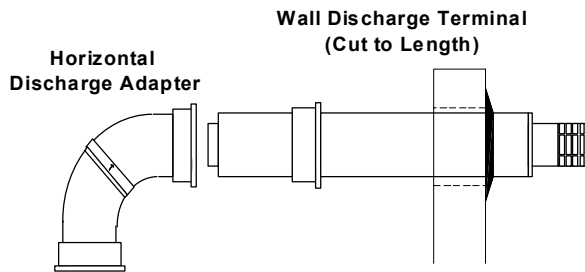

- 1) Connect the Horizontal Discharge Adapter to the water heater vent outlet. Make sure that the rubber seals are seated properly and that the fitting is fully engaged on the water heater.
- 2) Turn the Horizontal Discharge Adapter to the right or left of the water heater to the location the vent will penetrate the wall. Use a level, run from the top of the Horizontal Discharge Adapter to the location on the outside wall where the vent will penetrate the wall, to mark the top of the vent termination hole. Align the top of the Cut Line on the Wall Discharge Terminal Template (attached at the end of these instructions) with the mark just made. (Tape the template in place temporarily.)
- 3) Using a pencil, or a sharp scoring tool, mark the "PILOT HOLE" location by pressing hard enough to penetrate the template leaving a mark on the wall. Remove the template from the wall.
- 4) Using a 1/4" or smaller drill bit (long enough to drill completely through wall), drill a pilot hole from the inside wall surface completely through the outside wall surface.
IMPORTANT: Be certain the drill bit is kept level and straight during the drilling operation.
- 5) Using scissors, carefully cut the Wall Discharge Terminal Template along the outside edge of the dashed circle labeled "CUT LINE" leaving the hatched "Cut Line Template".
- 6) Align the "PILOT HOLE" on the "Cut Line Template" with the pilot hole drilled in the wall and using a pencil, carefully trace a cut line on the inside wall surface, along the edge of the "Cut Line Template". The cut line circle should be 5-1/4" in diameter.
- 7) Repeat Step 6 to trace a cut line on the exterior surface of the wall.
- 8) Using a cutting tool suitable for the wall construction (i.e. drill, skill saw, hole saw, etc.), drill or cut the vent termination hole through the wall along the cut lines drawn in Steps 6 and 7.

- 9) Remove the collar from the Wall Discharge Terminal (see Figure 7).

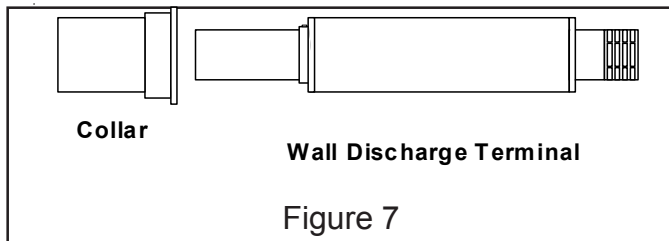

- 10) Loosen the screw on the metal Retaining Ring. Remove the Retaining Ring and the black plastic Alignment Spacer (see Figure 8).

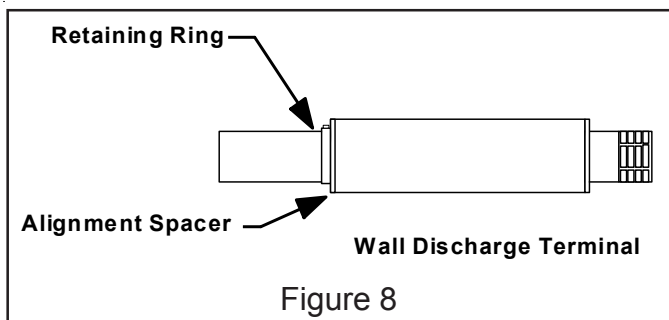

- 11) Disassemble the Wall Discharge Terminal. Remove the metal Exhaust Pipe, black plastic End Cap, and plastic Intake Pipe (see Figure 9).

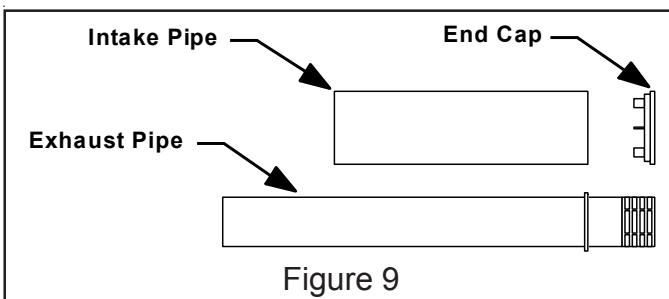

- 12) Measure the distance from the Horizontal Discharge Adapter Flange, through the vent termination hole, to the outside surface of the wall.

IMPORTANT: Take this measurement twice to be sure you have the correct measurement.

- 13) **Subtract 1"** from the measurement found in Step 12 giving you the required length of the plastic Intake Pipe.

- 14) Measure and mark the length calculated in Step 13 onto the plastic Intake pipe. Measure from either end and mark cut line all the way around the Intake Pipe (see Figure 10).

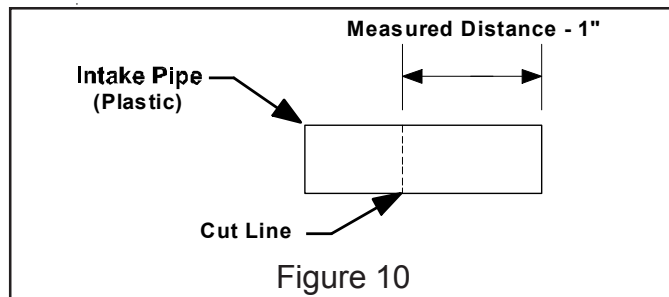

- 15) Use a hack saw and miter box to cut the Intake Pipe along the cut line marked in Step 14.

IMPORTANT: Make sure to cut the pipe squarely. Remove burrs from the pipe using a suitable de-burring tool or coarse sandpaper.

- 16) **Add 4 3/4"** to the wall thickness measured in Step 14 giving you the required length of the metal Exhaust Pipe.

- 17) Measure and mark the length calculated in Step 18 onto the metal exhaust pipe. Measure from the outside edge of the raised flange and mark a cut line all the way around the Exhaust Pipe (see Figure 11).

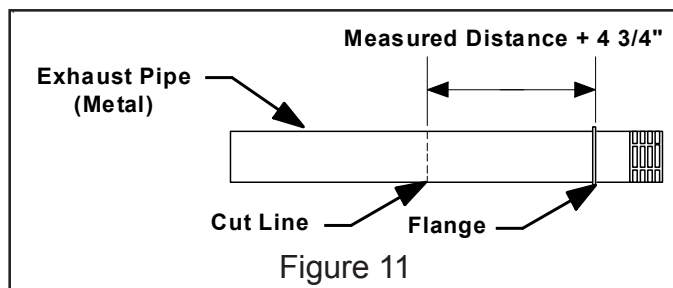

- 18) Use a hack saw and miter box to cut the Exhaust Pipe along the cut line marked in Step 17.

IMPORTANT: Make sure to cut the pipe squarely. Remove burrs from the pipe using a suitable de-burring tool or coarse sandpaper.

- 19) Reassemble the Wall Discharge Terminal. Insert the plastic End Cap into one end of the plastic Intake Pipe. Slide the metal Exhaust Pipe through the opening in the End Cap and through the Intake Pipe. Slide the plastic Alignment Spacer over the end of the Exhaust Pipe and insert into the end of the Intake Pipe. Slide the Retaining Ring over the Exhaust Pipe and tighten its screw to secure all parts tightly together. (Do not reinstall the Collar at this time.)
- 20) Slide the end of the Wall Discharge Terminal Collar into the Horizontal Discharge Adapter, making sure the pipe is pressed all the way into the intake pipe socket of the Horizontal Discharge Adapter.
- 21) From outside the building, slide the Wall Vent Terminal through the vent termination hole, through the Collar and into the Horizontal Discharge Adapter, making sure both the Intake Pipe and Exhaust Pipe connections are securely pressed into the sockets.
- 22) Seal between the plastic Intake Pipe and the cut openings of the interior and exterior surfaces of the wall, using silicon sealant.
- 23) The decorative wall plate may be installed on the exterior of the building to dress up the installation. Slide the wall plate over the vent pipe assembly and seal and secure using silicon sealant.

Non-Standard Installations Using Miscellaneous Rinnai Vent Components

Horizontal Venting with Extensions and Wall Termination:

When venting out an exterior wall some distance away from the water heater:

- 1) Determine the location that the Wall Discharge Terminal will be installed.
- 2) Place the Wall Discharge Terminal Template (attached at the end of these instructions) on the wall at this location. (Tape the template in place temporarily.)
- 3) Using a pencil, or a sharp scoring tool, mark the "PILOT HOLE" location by pressing hard enough to penetrate the template leaving a mark on the wall. Remove the template from the wall.
- 4) Using a 1/4" or smaller drill bit (long enough to drill completely through wall), drill a pilot hole from the inside wall service completely through the outside wall surface.
IMPORTANT: Be certain the drill bit is kept level and straight during the drilling operation.
- 5) Using scissors, carefully cut the Wall Discharge Terminal Template along the outside edge of the dashed circle labeled "CUT LINE" leaving the hatched "Cut Line Template".
- 6) Align the "PILOT HOLE" on the "Cut Line Template" with the pilot hole drilled in the wall and using a pencil, carefully trace a cut line on the inside wall surface, along the edge of the "Cut Line Template". The cut line circle should be 5-1/4" in diameter.
- 7) Repeat Step 6 to trace a cut line on the exterior surface of the wall.
- 8) Using a cutting tool suitable for the wall construction (i.e. drill, skill saw, hole saw, etc.), drill or cut the vent termination hole through the wall along the cut lines drawn in Steps 6 and 7.
- 9) Connect the Horizontal Discharge Adapter or the Vertical Discharge Adapter (whichever is appropriate for your installation) to the water heater vent outlet. Make sure that the rubber seals are seated properly and that the fitting is fully engaged on the water heater.

- 10) Continuing from the Discharge Adapter, and working toward the Wall Discharge Terminal, connect all of the other venting system components (DO NOT install the Wall Discharge Terminal at this time.) Make sure that the rubber seals are seated properly and that the fitting is fully engaged on the water heater.
IMPORTANT: Support the vent pipe at every joint of pipe using vent pipe clamps, or sheet metal hangers.
- 11) Measure the distance from the Flange of the last fitting or pipe extension, through the vent termination hole, to the outside surface of the wall.
IMPORTANT: Take this measurement twice to be sure you have the correct measurement.
- 12) **Subtract** 1" from the measurement found in Step 11 giving you the required length of the plastic Intake Pipe.
- 13) Remove the collar from the Wall Discharge Terminal (see Figure 7).
- 14) Loosen the screw on the metal Retaining Ring. Remove the Retaining Ring and the black plastic Alignment Spacer (see Figure 8).
- 15) Disassemble the Wall Discharge Terminal. Remove the metal Exhaust Pipe, black plastic End Cap, and plastic Intake Pipe (see Figure 9).
- 16) Measure and mark the length calculated in Step 12 onto the plastic Intake pipe. Measure from either end and mark cut line all the way around the Intake Pipe (see Figure 10).
- 17) Use a hack saw and miter box to cut the Intake Pipe along the cut line marked in Step 16.
IMPORTANT: Make sure to cut the pipe squarely. Remove burrs from the pipe using a suitable de-burring tool or coarse sandpaper.
- 18) **Add** 4 3/4" to the wall thickness measured in Step 16 giving you the required length of the metal Exhaust Pipe.
- 19) Measure and mark the length calculated in Step 18 onto the metal exhaust pipe. Measure from the outside edge of the raised flange and mark a cut line all the way around the Exhaust Pipe (see Figure 11).
- 20) Use a hack saw and miter box to cut the Exhaust Pipe along the cut line marked in Step 19.
IMPORTANT: Make sure to cut the pipe squarely. Remove burrs from the pipe using a suitable de-burring tool or coarse sandpaper.
- 21) Reassemble the Wall Discharge Terminal. Insert the plastic End Cap into one end of the plastic Intake Pipe. Slide the metal Exhaust Pipe through the opening in the End Cap and through the Intake Pipe. Slide the plastic Alignment Spacer over the end of the Exhaust Pipe and insert into the end of the Intake Pipe. Slide the Retaining Ring over the Exhaust Pipe and tighten its screw to secure all parts tightly together. (Do not reinstall the Collar at this time.)
- 22) Slide the end of the Wall Discharge Terminal Collar into the last fitting or pipe extension of the venting system, making sure the pipe is pressed all the way into the intake pipe socket of the fitting or pipe extension.
- 23) From outside the building, slide the Wall Vent Terminal through the vent termination hole, through the Collar and into the last fitting of the vent pipe system, making sure both the Intake Pipe and Exhaust Pipe connections are securely pressed into the sockets.
- 24) Seal between the plastic Intake Pipe and the cut openings of the interior and exterior surfaces of the wall, using silicon sealant.
- 25) The decorative wall plate may be installed on the exterior of the building to dress up the installation. Slide the wall plate over the vent pipe assembly and seal and secure using silicon sealant.

Vertical Venting with Extensions and Roof Termination:

When venting vertically through a roof a maximum of 21' above the water heater:

- 1) Determine the location that the Roof Discharge Terminal will be installed.
- 2) Using a cutting tool suitable for the roof construction, cut a hole through the through the roof decking a suitable size for the Flashing Assembly being used. (6" x 6" hole for flat roof, 9" x 6" for 12/12 pitch, or 12" x 6" hole for 16/12 pitch).
- 3) Install the Roof Flashing Assembly using suitable fasteners for the roof decking (see Figure 12)..

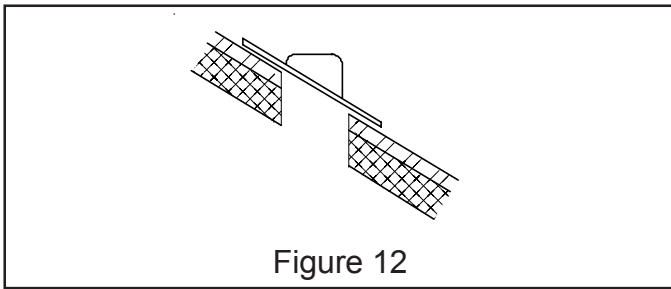

- 4) Remove the Collar from the Roof Discharge Terminal and Slide the Roof Discharge Terminal down through the Roof Flashing Assembly fully engaging the Discharge Terminal into the Flashing Assembly (see Figure 13).

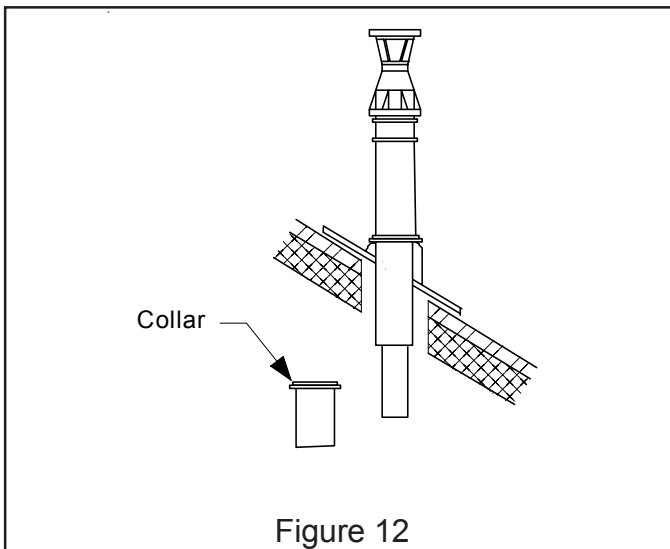

- 5) Connect the Collar to the Discharge Terminal.
- 6) Connect the Horizontal Discharge Adapter or the Vertical Discharge Adapter (whichever is appropriate for your installation) to the water heater vent outlet. Make sure that the rubber seals are seated properly and that the fitting is fully engaged on the water heater.
- 7) Continuing from the Discharge Adapter, and working toward the Roof Discharge Terminal, connect all of the other venting system components leaving out the final pipe extension connecting to the Discharge Terminal (DO NOT install the Roof Discharge Terminal at this time.) Make sure that the rubber seals are seated properly and that the fitting is fully engaged on the water heater.

IMPORTANT: Support the vent pipe at every joint of pipe using vent pipe clamps, or sheet metal hangers.

- 8) Measure the distance from the Flange of the last pipe extension to the plastic Intake Pipe of the Roof Discharge Terminal (see Figure 13).

IMPORTANT: Take this measurement twice to be sure you have the correct measurement.

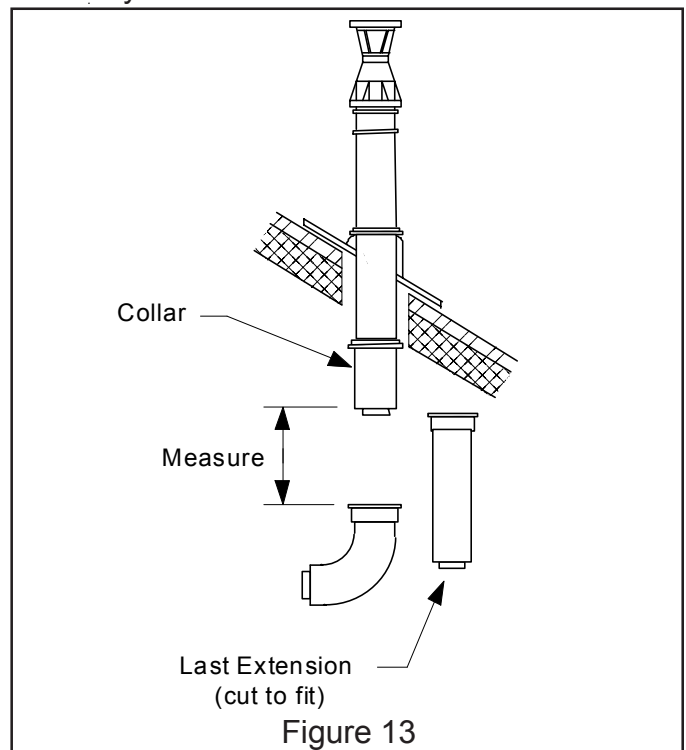

NOTE: If the last connection to the Roof Discharge Terminal is an Elbow Fitting, cut the last vertical pipe extension in the vent system. **DO NOT** attempt to cut the Roof Discharge Terminal.

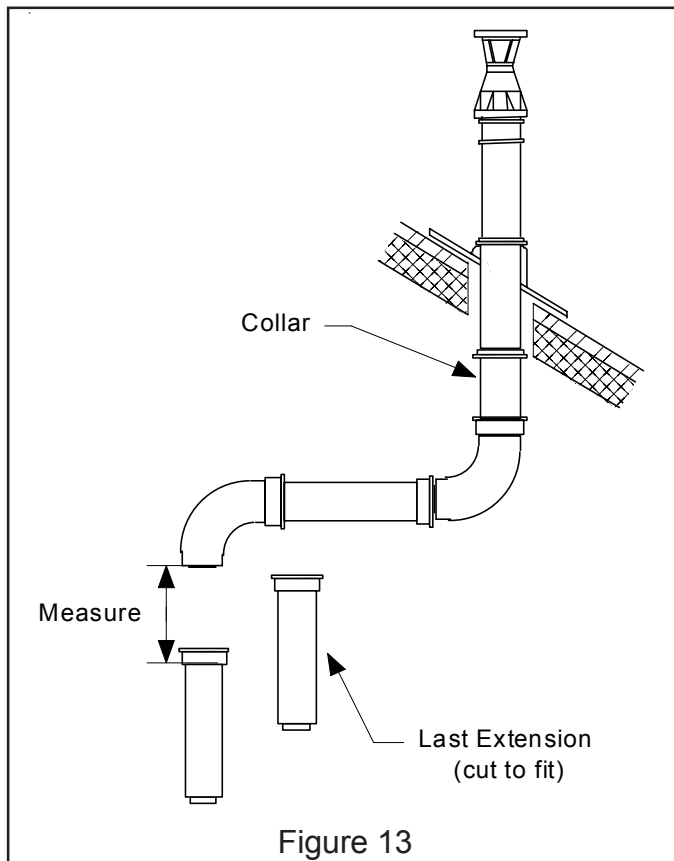

the metal Exhaust Pipe back through the End Cap and Intake Pipe.

- 14) Install this last pipe extension, tying the Roof Discharge Terminal to the rest of the Venting System. Make sure the pipe is pressed all the way into the intake pipe socket of the fitting or pipe extension.
- 15) Seal all exterior gaps and seems of the Roof Discharge Terminal using a silicon sealant.
- 16) Make sure the Roof Discharge Terminal is Vertically Plumb, use a level if needed, and then secure the Roof Discharge Terminal to the interior roof construction using a Vent Pipe Clamp.

- 9) **Add** 2 1/2" to the measurement found in Step 8 giving you the required length of the plastic Intake Pipe for the Pipe Extension connecting to the Roof Discharge Terminal.
- 10) Remove the metal Exhaust Pipe from the Pipe Extension connecting to the Roof Discharge Terminal.
- 11) Cut the plastic Intake Pipe for the Pipe Extension connecting to the Roof Discharge Terminal to the length calculated in Step 9.
- 12) The metal Exhaust Pipe for the Pipe Extension must be 3/4" longer than the Intake Pipe. Measure the length of the plastic Intake Pipe and **ADD** 3/4" to its length -- this is the required length of the metal Exhaust Pipe. Measure and cut the Exhaust Pipe to this length.

13) Reassemble the last Pipe Extension by sliding

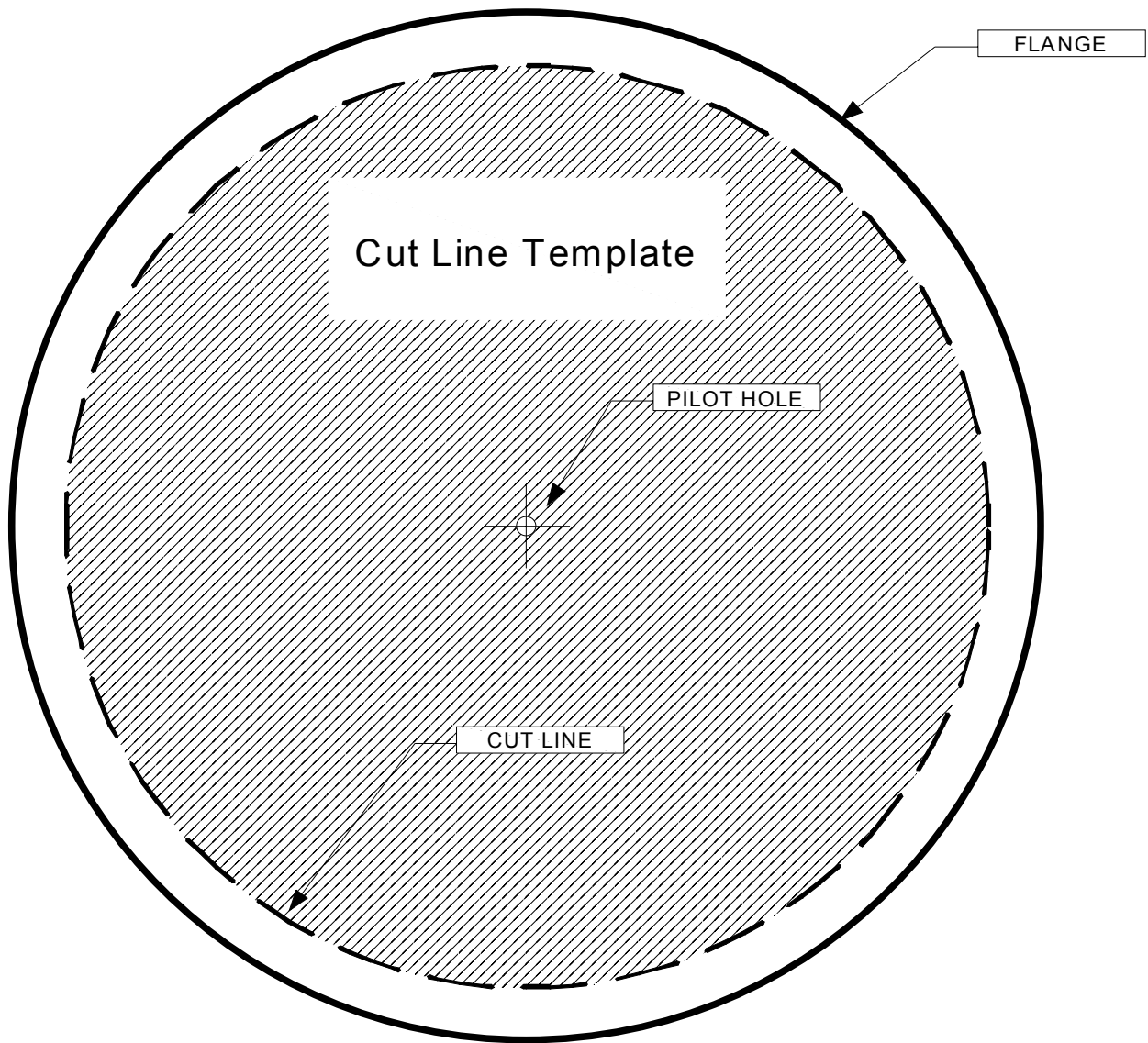

Rinnai

103 International Drive
Peachtree City, GA 30269

RINNAI DIRECT VENT WATER HEATERS

Wall Discharge Terminal Template